

# Studies of Glutenin. XII. Comparison by Sodium Dodecyl Sulfate-Polyacrylamide Gel Electrophoresis of Unreduced and Reduced Glutenin From Various Isolation and Purification Procedures<sup>1</sup>

K. KHAN and W. BUSHUK, Department of Plant Science, University of Manitoba, Winnipeg, Canada R3T 2N2

## ABSTRACT

Cereal Chem. 56(2):63-68

Glutenin was isolated from flour by several different published procedures. Examination of two crude glutenin preparations (modified Osborne acetic acid-soluble and 2-chloroethanol extract of residue protein) and four purified glutenin preparations, both in unreduced and reduced form, by sodium dodecyl sulfate-polyacrylamide gel electrophoresis (SDS-

PAGE), showed that unreduced glutenin contains many protein components that enter the SDS-gel. These components correspond, in mobility, to many of the subunits of reduced glutenin identified by SDS-PAGE. A model of functional glutenin which includes subunits bound by noncovalent linkages is presented.

The influence of glutenin in determining bread-making quality was demonstrated by rheological, baking, and protein fractionation studies (Bietz and Wall 1975, Orth and Bushuk 1972, Shogren et al 1969, Tanaka and Bushuk 1973). Those studies described mainly two types of glutenin, namely the acetic acid-soluble and the acetic acid-insoluble glutenins. It was shown that bread-making quality is negatively correlated with the proportion of the acetic acid-soluble glutenin and positively with the proportion of acetic acid-insoluble glutenin (residue protein) (Orth and Bushuk 1972). These two types of glutenin were subsequently purified and examined after reduction by sodium dodecyl sulfate-polyacrylamide gel electrophoresis (SDS-PAGE) (Bietz and Wall 1975, Orth and Bushuk 1973b). It was assumed in these studies and in those of Ewart (1968, 1972, 1977) that glutenin comprises large molecules of 15 to 20 polypeptide subunits joined together by interpolypeptide disulfide bonds.

A recent report from this laboratory (Khan and Bushuk 1977), showed that unreduced glutenin contained some protein components that entered the SDS-gel. This article examines in greater detail unreduced and reduced glutenins by SDS-PAGE prepared by several isolation and purification procedures as a basis for a new model of the functional glutenin.

## MATERIALS AND METHODS

### Wheat and Flour

Glutenins used in this study were isolated from defatted flours milled on a pneumatic Buhler experimental mill. The wheat cultivars were hard red spring wheats, Red River 68 and Manitou; hard red winter wheat, Ponca (supplied by J. A. Bietz, USDA, Peoria, IL); and soft white winter wheat, Talbot. These cultivars were selected to cover a wide range of bread-making quality. Each flour was defatted first with 1-butanol and then with petroleum ether, as described by Bietz and Wall (1975), before it was used for the extraction of glutenin.

### Glutenin Extraction Procedures

*Procedure I.* Glutenin was extracted according to the single-kernel procedure of Bietz et al (1975). Our previous study (Khan and Bushuk 1977) (Fig. 6A) showed that many prominent protein components entered the SDS-gel from unreduced glutenin from the single-kernel procedure. It was concluded that this glutenin was

not sufficiently purified. Accordingly, the purification procedure of Bietz et al (1975) was used in an attempt to remove the extraneous proteins that entered SDS-gels.

The original procedure of Bietz et al (1975) was modified as follows: The volumes of the sodium chloride and ethanol solutions were increased to 10 ml from 5 ml. Three 0.5-hr extractions were made with the salt solution and four similar extractions with the ethanol solution. The residue remaining after the ethanol extractions was dispersed in 4 ml (instead of 2) of 0.7% acetic acid and stirred for 1 hr instead of 0.5 hr. The suspension was then made 70% in ethanol and stirred for 0.5 hr. The pH of the acetic acid-ethanol suspension was adjusted to 6.6 with 2N NaOH, and was left for 5 hr at 4°C to allow the acetic acid-soluble glutenin to precipitate. The preparation was then centrifuged and the supernatant, presumed to contain the extraneous proteins, was discarded. The precipitate was redispersed in 4 ml of 0.7% acetic acid and the pH precipitation procedure repeated. The resulting twice-precipitated purified glutenin was freeze-dried and later examined by SDS-PAGE.

For additional fractionation, the purified glutenin was then extracted overnight with 0.3 ml of 0.125M Tris-borate buffer, pH 8.9, containing 1% (w/v) SDS. The suspension was centrifuged on a bench-top centrifuge for 3 min, and the supernatant retained for electrophoresis. This extraction with SDS-Tris-borate was repeated four more times, and each supernatant was retained separately. The residue remaining after the five extractions was suspended in 0.1 ml of SDS-Tris-borate buffer containing 1%  $\beta$ -mercaptoethanol. The suspension was centrifuged, and the supernatant containing reduced purified glutenin was retained for electrophoresis.

*Procedure II.* Glutenin was extracted according to the modified Osborne solubility fractionation procedure of Bietz and Wall (1975). Flour was sequentially extracted with sodium chloride solution, 70% aqueous ethanol, and solutions of acetic acid (HOAc), mercuric chloride ( $\text{HgCl}_2$ ), and  $\beta$ -mercaptoethanol. This fractionation yields the following protein fractions, respectively: albumins and globulins; gliadins, HOAc-soluble glutenin,  $\text{HgCl}_2$ -soluble glutenin, and  $\beta$ -mercaptoethanol-soluble glutenin. Subsequently, the HOAc-soluble and  $\text{HgCl}_2$ -soluble glutenins were purified by the pH precipitation procedure of Jones et al (1959). The supernatants from these purifications, containing extraneous proteins, were retained for comparison with the equivalent purified glutenin preparations. The ethanol in the supernatant was evaporated on a rotary evaporator and the residue containing the contaminating proteins was dissolved in 0.01N acetic acid and freeze-dried for analysis by SDS-PAGE.

*Procedure III.* Glutenin was prepared according to the pH precipitation procedure of Jones et al (1959).

*Procedure IV.* Glutenin was prepared according to the pH precipitation procedure of Orth and Bushuk (1973a).

<sup>1</sup>Contribution 516 of the Department of Plant Science, University of Manitoba, Winnipeg, Canada, R3T 2N2, with financial assistance from the National Research Council of Canada.

### Sodium Dodecyl Sulfate-Polyacrylamide Gel Electrophoresis

SDS-PAGE was performed at pH 8.9 as described by Khan and Bushuk (1977). When reduction (with  $\beta$ -mercaptoethanol) of glutenin was not required, the reducing agent was omitted from the solvent used to dissolve (disperse) the protein for electrophoresis. Staining and destaining procedures were as described by Khan and Bushuk (1977). In some instances, electrophoregrams will be presented in the form of interpretive drawings to facilitate identification of diffuse bands.

### RESULTS AND DISCUSSION

The SDS-PAGE patterns of unreduced purified glutenin (Fig. 1) from the single-kernel procedure (procedure I) show that this glutenin still contains many proteins that enter the SDS-gel (patterns B, C, D). Patterns B, C, and D represent first, third, and fifth extractions with SDS-Tris-borate buffer, respectively. All five extracts contained proteins, although in trace amounts, that entered the SDS-gel. Many of these proteins correspond, in mobility, to subunits of the reduced purified glutenin (residue) (pattern E). However, the first five high molecular weight (mol wt) subunits, which are clearly resolved and are prominent in the patterns for reduced total glutenin (A) and the residue (E), are not present in the patterns of the unreduced samples. Bands of subunits

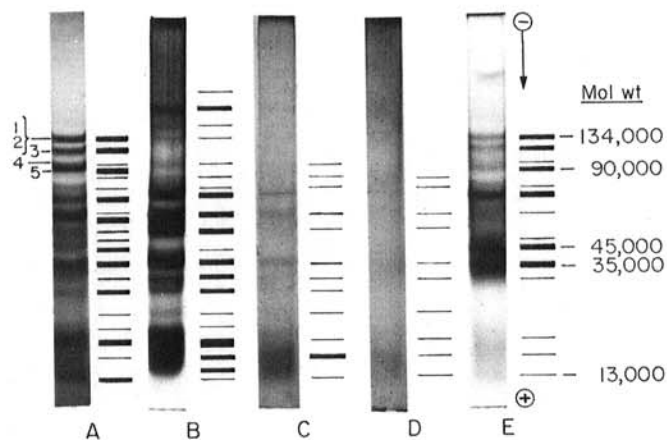

Fig. 1. Sodium dodecyl sulfate-polyacrylamide gel electrophoresis (SDS-PAGE) of purified glutenin (of the cultivar Manitou) prepared by the single-kernel procedure of Bietz et al (1975). A, total glutenin; B, C, D, first, third, and fifth extractions with Tris-borate-SDS buffer without reducing agent; E, reduced glutenin from the residue after the fifth extraction.

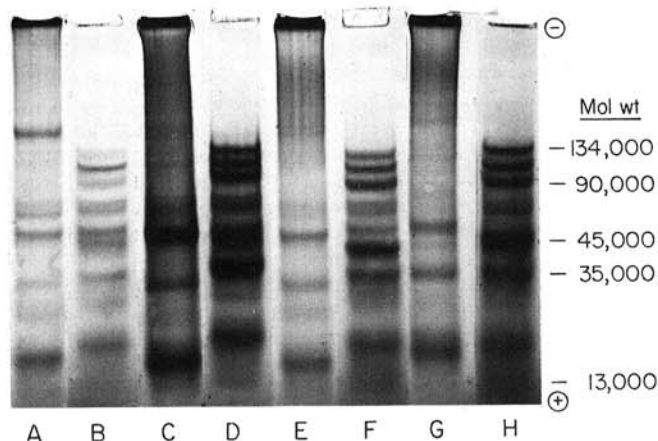

Fig. 2. SDS-PAGE of the purified acetic acid-soluble glutenin (Bietz and Wall 1975). A, B, unreduced and reduced Red River 68 glutenin; C, D, unreduced and reduced Manitou glutenin; E, F, unreduced and reduced Ponca glutenin; G, H, unreduced and reduced Talbot glutenin.

with molecular weights in the 60,000–45,000 and 35,000–13,000 mol wt regions, which are evident in patterns B, C, and D, are very faint in pattern E. As will be shown later, these subunits are particularly prominent in patterns of reduced acetic acid-soluble (see Fig. 2) glutenin. Since these subunits can be extracted with SDS-Tris-borate buffer, without reduction, presumably they are held in the glutenin complex by noncovalent bonds.

The presence of low molecular weight subunits in the glutenin that was extensively purified (as shown by SDS-PAGE) may be analogous to the gel-filtration results of Dalek-Zawistowska et al (1975). These workers reported that rechromatography of glutenin (originally isolated from gluten by gel-filtration on Sephadex) on Sephadex G-200 produced two protein peaks, the second peak eluting in the molecular weight region of gliadin proteins. They postulated an equilibrium dissociation of high molecular weight glutenin into low molecular weight species that elute as peak II on rechromatography of pure glutenin (peak I).

### Glutenin From Procedure II

The SDS-PAGE results on glutenin prepared by procedure I prompted the examination of unreduced and reduced glutenin prepared by other procedures.

Figure 2 shows the SDS-PAGE patterns of the purified (Jones et al 1959) unreduced and reduced HOAc-soluble glutenin of four common wheat cultivars of widely different baking quality. In all four patterns of unreduced glutenins (A, C, E, G), many prominent low molecular weight protein components entered the SDS-gels. In each case there was evidence of considerable protein at the point of sample application. Intercultivar comparison of the patterns of unreduced HOAc-soluble glutenin suggests cultivar differences in the amount of low molecular weight glutenin. This agrees with an earlier report that the amount of HOAc-soluble glutenin is negatively correlated to bread-making quality (Orth and Bushuk 1972). The patterns of reduced HOAc-soluble glutenin (Fig. 2, B, D, F, H) appear to be qualitatively identical for the four cultivars.

Figure 3 shows the SDS-PAGE patterns of the purified unreduced and reduced  $HgCl_2$ -soluble glutenin of the same four cultivars examined in Fig. 2. (Figure 3 is a composite of patterns cut from several gels; some patterns took on a curved shape when the composite gel was prepared for photography.) The patterns for the unreduced samples (A, C, E, G) show many prominent protein components in the  $>60,000$  mol wt region, unlike the HOAc-soluble glutenin (Fig. 2, A, C, E, G), which showed more prominent bands in the  $<60,000$  mol wt region. These results support the conclusion of Danno et al (1975) that  $HgCl_2$  can cleave some of the disulfide bonds of glutenin. This reaction of  $HgCl_2$  also accounts for the ability of HOAc- $HgCl_2$  solutions to dissolve residue protein (Bietz and Wall 1975) and gel protein (Mecham et al 1972).

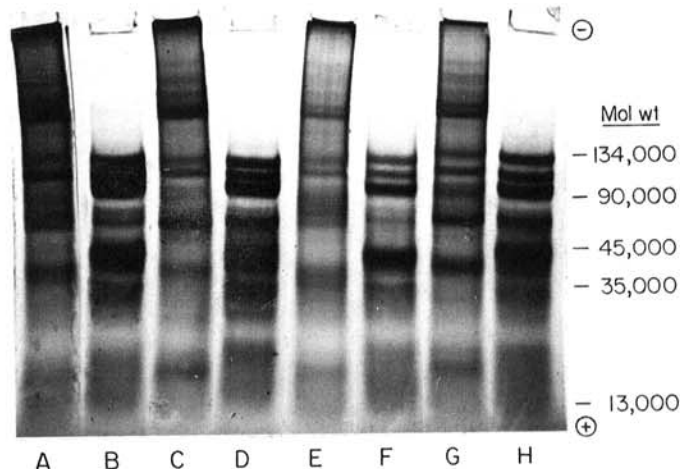

Fig. 3. SDS-PAGE of the purified mercuric chloride-soluble glutenin (Bietz and Wall 1975). A, B, unreduced and reduced Red River 68 glutenin; C, D, unreduced and reduced Manitou glutenin; E, F, unreduced and reduced Ponca glutenin; G, H, unreduced and reduced Talbot glutenin.

The patterns of the reduced  $\text{HgCl}_2$ -soluble glutenins of the four cultivars (B, D, F, H) are qualitatively identical (Fig. 3). These patterns also are qualitatively similar to the patterns for the reduced HOAc-soluble glutenins (B, D, F, H) (Fig. 2). There are minor quantitative differences in the  $<40,000$  mol wt region where the bands are more intensely stained in the patterns of the HOAc-soluble glutenin.

Figure 4 shows the SDS-PAGE patterns of unreduced Chinese Spring and Ponca glutenins prepared by Bietz (USDA, Peoria, IL) by various procedures. As can be seen, these preparations also contain many protein components that enter the SDS-gel. The components are similar in mobility to those present in the glutenins prepared in our laboratory. Pattern A, the reduced HOAc-soluble glutenin of Manitou, is presented for comparison.

Many of the protein components that enter the SDS-gel from unreduced and reduced glutenin correspond in mobility to components in the albumin, globulin, and gliadin fractions (Fig. 5). On the basis of electrophoretic mobility only, the protein components (subunits) from unreduced glutenin that enter the SDS-gel could indeed be albumin, globulin, and gliadin contaminants. Since these components appear to remain with the glutenin fraction even after extensive solvent extraction (see for example Fig. 1), however, they are considered to be an integral part of the glutenin complex.

#### Extraction of Residue Protein

The protein remaining after sequential extraction of flour with sodium chloride, ethanol, and HOAc solutions is usually referred to as residue protein (or insoluble glutenin). Bietz and Wall (1975) reported that  $\text{HgCl}_2$  in HOAc can solubilize most of insoluble residue protein. Two other solvents, AUC (0.1N acetic acid-3M urea-0.01M hexadecyltrimethyl ammonium bromide) and 70% chloroethanol-0.1N HCl, were examined as potential solvents of the residue protein. After each extraction, the supernatant was dialyzed against distilled water and freeze-dried. The freeze-dried samples were analyzed by SDS-PAGE and the patterns compared with those of HOAc-soluble glutenin.

The components that enter the SDS-gel from the unreduced AUC and chloroethanol extracts gave much fainter bands than those of the HOAc-soluble glutenin (Fig. 6). Also, there is more high molecular weight material at the point of sample application in the patterns of the AUC and chloroethanol extracts than in those of the HOAc extract. (In this experiment, the same amount of protein was applied to each slot.) When the three extracts were reduced, the first five high molecular weight subunits of the AUC and chloroethanol extracts stained much more intensely than the corresponding subunits of the HOAc extract. The 68,000 and 60,000 mol wt subunits, however, stained more prominently in the pattern of the HOAc extract. The subunits in the 45,000 and lower mol wt region stained with approximately the same intensity in the patterns of all three extracts. These results show that the AUC and chloroethanol extracts of the residue protein (insoluble glutenin) contain proportionately more high molecular weight subunits (that do not enter SDS-gels without reduction) than the HOAc-soluble glutenin fraction. The results also show that chloroethanol-HCl does not modify the structure of glutenin (residue protein) as does  $\text{HgCl}_2$  (compare Figs. 3A and 6E).

#### Glutenin Isolated From the Gliadin Fraction

During these investigations, we noted that some high molecular weight protein remained at the point of sample application when the unreduced gliadin fraction, isolated according to the procedure of Bietz and Wall (1975), was subjected to SDS-PAGE. This material was presumed to be glutenin. To confirm this, the gliadin fraction was subjected to purification by the pH precipitation procedure of Jones et al (1959) in an attempt to separate the high molecular weight material. The fraction so isolated was compared with the HOAc-soluble glutenin.

Figure 7 shows SDS-PAGE patterns of the total gliadin fraction, the precipitated protein (presumably glutenin), and the protein remaining in the supernatant after precipitation of glutenin, both in unreduced and reduced forms. The pattern of the unreduced precipitate shows considerable material at the origin and only faint bands in the SDS-gel. Reduced precipitate shows fewer bands than

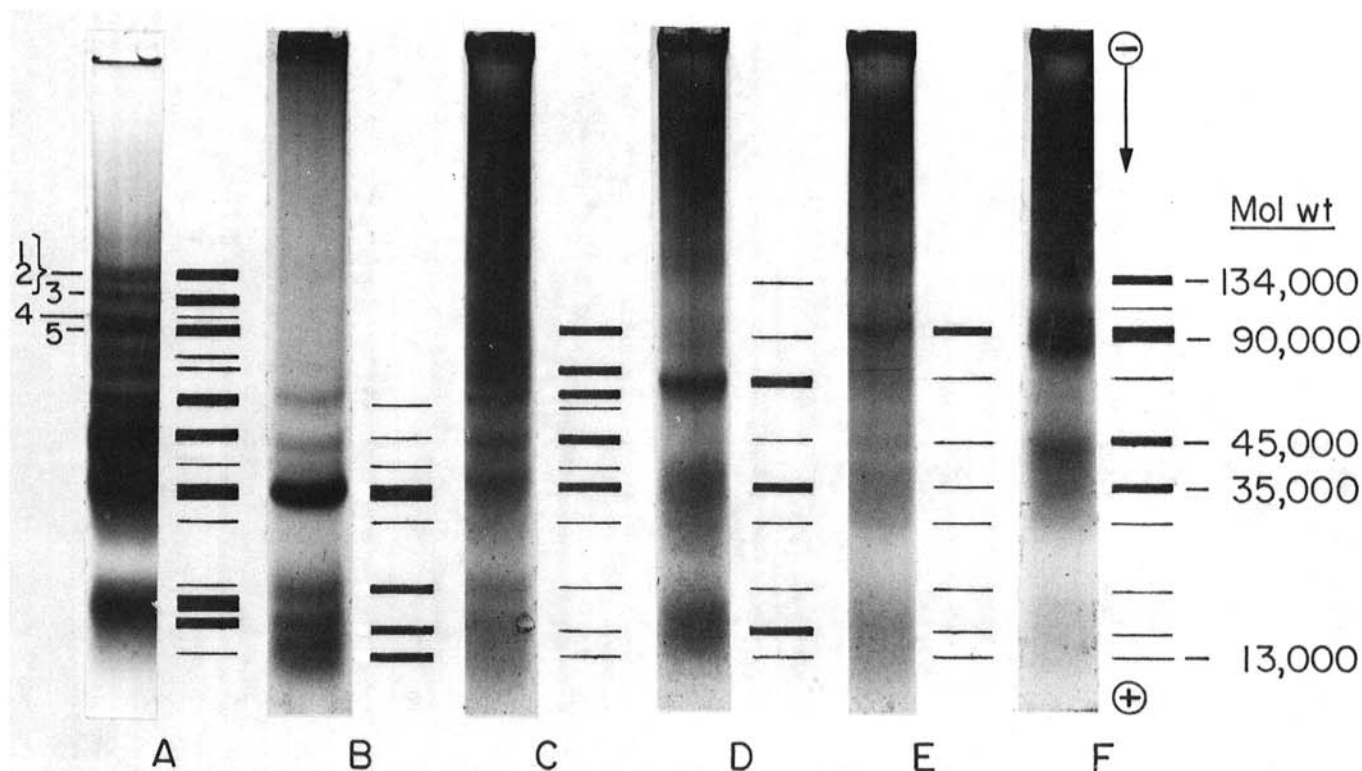

Fig. 4. SDS-PAGE of unreduced purified glutenin prepared by Bietz (USDA, Peoria, IL). A, reduced acid-soluble glutenin of the cultivar Manitou (prepared by authors); B, Chinese Spring acetic acid-soluble glutenin; C, Chinese Spring mercuric chloride-soluble glutenin; D, Ponca acetic acid-soluble glutenin; E, Ponca mercuric chloride-soluble glutenin; F, Ponca twice precipitated glutenin according to Jones et al (1959).

the reduced HOAc-soluble glutenin; components of molecular weight between 80,000 and 45,000 and 30,000 and lower are essentially absent in the reduced HOAc-soluble glutenin (F). These results show that the gliadin prepared by the procedure of Bietz and Wall (1975) contains considerable glutenin, but this glutenin appears to be different from the HOAc-soluble glutenin (by SDS-PAGE).

#### Supernatant Fraction From the pH Precipitation Procedure

Figure 8 shows the patterns of the supernatants from the purification of HOAc-soluble and HgCl<sub>2</sub>-soluble glutenin, and of total reduced glutenin of the cultivar Manitou. The pattern of the supernatant of the HOAc-soluble glutenin (A) show more intensely stained bands in the <35,000 mol wt region, but the pattern of the

supernatant of the HgCl<sub>2</sub>-soluble glutenin (B) contains more intensely stained bands in the >35,000 mol wt region, especially the subunits of 35,000 and 68,000 mol wt. Two other cultivars, Red River 68 and Talbot, contained equal amounts of 35,000 and 45,000 mol wt components in the supernatant of the HgCl<sub>2</sub>-soluble glutenin. These differences between supernatants of the HOAc-soluble and HgCl<sub>2</sub>-soluble glutenin fractions can be explained by the chemical modification (reduction of disulfide bonds) of the

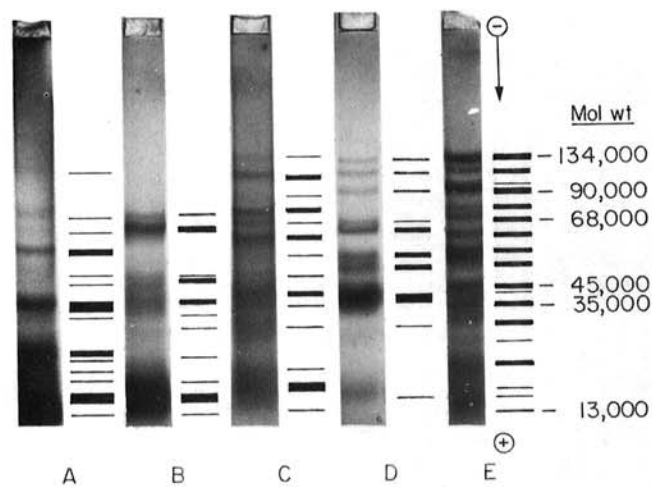

Fig. 5. SDS-PAGE of the protein fractions from the modified Osborne procedure of Bietz and Wall (1975) of the cultivar Manitou. A, unreduced acetic acid-soluble glutenin; B, C, D, reduced albumins, globulins, and gliadins, respectively; E, reduced acetic acid-soluble glutenin.

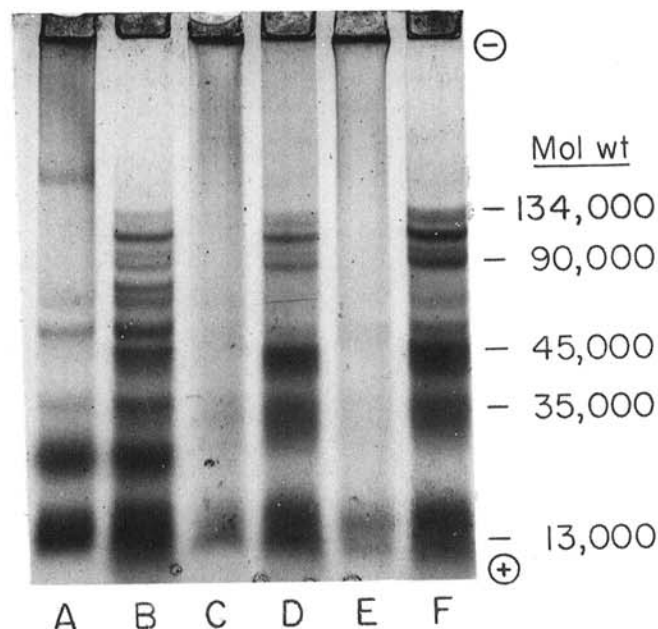

Fig. 6. SDS-PAGE of glutenin of Red River 68 prepared by different procedures. A, B, unreduced and reduced acetic acid-soluble glutenin; C, D, unreduced and reduced AUC extract of residue protein; E, F, unreduced and reduced chloroethanol extract of residue protein. (The same amount of nitrogen [protein] was applied in each case.)

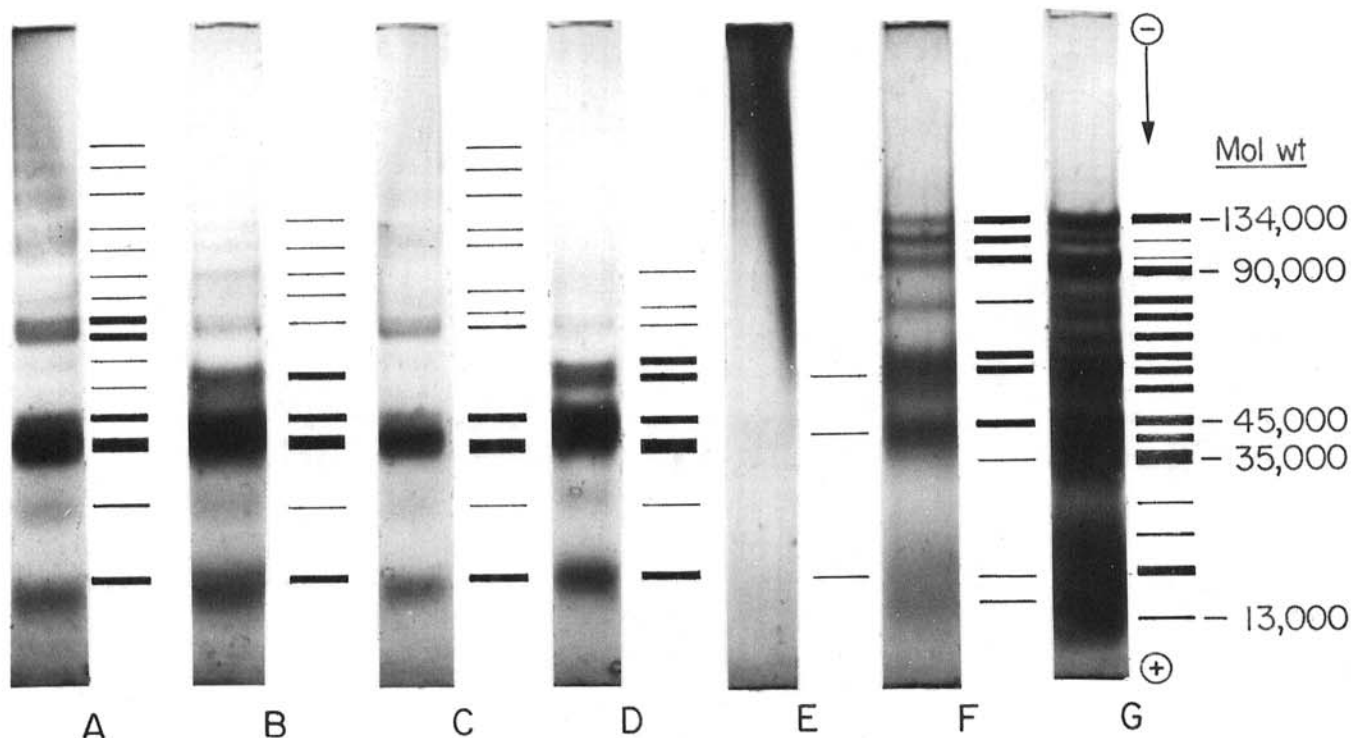

Fig. 7. SDS-PAGE of glutenin isolated from the gliadin fraction of Bietz and Wall (1975) of Manitou according to the pH precipitation procedure of Jones et al (1959). A, B, unreduced and reduced gliadin; C, D, unreduced and reduced soluble proteins from pH precipitation of glutenin in gliadin extract; E, F, unreduced and reduced glutenin precipitated from gliadin extract; G, reduced acetic acid-soluble glutenin.

glutenin by HgCl<sub>2</sub>. The 35,000, 45,000, and 68,000 mol wt components become more soluble after partial reduction of glutenin with HgCl<sub>2</sub>. Bietz and Wall (1973) identified gliadin-like subunits of glutenin (35,000 and 45,000 mol wt) after reduction and alkylation of glutenin. Obviously, the structure of glutenin is not altered by HOAc the way it is by HgCl<sub>2</sub>.

### DISCUSSION

The SDS-PAGE results show that previous researchers used somewhat different glutenin preparations for essentially the same purpose, namely, to elucidate the structure to function relationship of glutenin in bread making. Those researchers concerned with the function of glutenin in bread making (Orth and Bushuk 1972, Shogren et al 1969) used "crude" glutenin preparations from the Osborne or similar solubility fractionation procedure. On the other hand, those researchers concerned with fundamental physico-chemical studies (Bietz and Wall 1975, Jones et al 1959, Mita and Yonezawa 1971, Orth and Bushuk 1973a) used more or less "purified" glutenins. In most of the fundamental studies, the aim of the purification was to remove the low molecular weight contaminants, which, because of their similarity in electrophoretic mobility to albumin, globulin, and gliadin proteins, were assumed to be these latter proteins. The basic assumption made by most researchers is that glutenin is an extremely large molecule consisting of polypeptide subunits joined to one another through interpolypeptide disulfide bonds. Because of its large size, glutenin should not enter a 5% polyacrylamide gel. Therefore, protein components that enter a 5% polyacrylamide gel from an unreduced glutenin preparation were considered to be contaminants.

SDS-PAGE results presented in this article of the unreduced glutenin preparations suggest that there are two groups of proteins in the glutenin complex: those that enter the SDS-gel and those that remain at the point of sample application. These results raise the question as to the relative importance, in bread-making quality, of these two types of glutenin proteins. Perhaps, the relative quantities or the ability of these components to form specific aggregates may be important factors in determining bread-making quality.

Because the so-called contaminants seem to form an integral part of the glutenin complex, it is suggested that they should be

classified as part of the glutenin. A simplistic model (Fig. 9) of functional glutenin was developed on the basis of this new information. This model is an alternate to those of Ewart (1977) and Kasarda et al (1976).

According to the model, the glutenin complex (aggregate) comprises two types of proteins. The first type, designated as glutenin I (Glu I) are proteins that are held in the complex by strong noncovalent forces. Glu I proteins enter the gels when various unreduced glutenin preparations are subjected to SDS-PAGE. It comprises mainly subunits with molecular weights of 68,000 and lower and is quite soluble in acetic acid solution and other dissociating solvents.

The second type of glutenin protein, designated as glutenin II (Glu II), comprises either large molecules (in which polypeptide subunits are joined by interpolypeptide disulfide bonds) or aggregates (in which the subunits are held together by very strong noncovalent forces). The stability of the noncovalent aggregates depends on the presence of intramolecular disulfide bonds. Recent results of Kobrehel and Bushuk (1977), which showed that sodium stearate or similar soaps can completely solubilize glutenin, suggest that virtually all glutenin comprises aggregates in which highly specific hydrophobic interactions hold subunits together. In SDS-PAGE, Glu II, if not reduced, remains at the point of sample application since it cannot enter the 5% polyacrylamide gel because of its larger size. Upon reduction of its disulfide bonds (interpolypeptide or intrapolypeptide type), Glu II dissociates into subunits with molecular weights of 68,000 and higher.

Not all of Glu I enters SDS-gels from an unreduced total glutenin preparation, since some of it appears to be extremely tightly bound or trapped within compactly folded Glu II. Only when the structure of Glu II is destroyed by reduction are all the Glu I components released from the complex.

The model shown in Fig. 9 is qualitatively consistent with the known rheological properties (viscoelasticity) of hydrated glutenin. The physical interactions between Glu I and Glu II provide for the mobility required for viscous flow under stress, and the disulfide crosslinks of Glu II contribute the elastic component. More research is needed, however, to develop a detailed relation between glutenin structure and its rheological properties.

### SUMMARY

SDS-PAGE of unreduced and reduced glutenin from different isolation and purification procedures showed that many of the subunits of glutenin are noncovalently bound in a glutenin complex or aggregate (micelle). It is postulated that the high molecular weight subunits of glutenin form the network, through either covalent S-S bonds or extremely strong noncovalent forces (Glu II) that contain the noncovalently bound smaller subunits (Glu I). A model of glutenin complex, based on current knowledge, is presented.

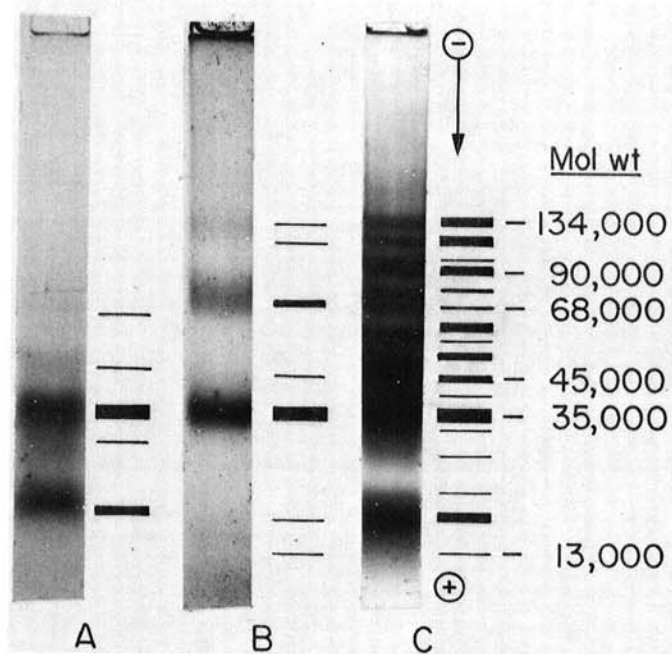

Fig. 8. SDS-PAGE of the unreduced supernatant proteins from the pH precipitation of the acetic acid-soluble and mercuric chloride-soluble glutenins of Manitou. A, supernatant from the acetic acid-soluble glutenin; B, supernatant from the HgCl<sub>2</sub>-soluble glutenin; D, total acetic acid-soluble glutenin.

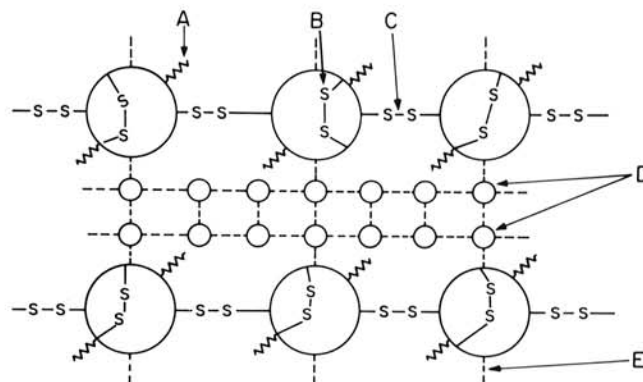

Fig. 9. Schematic representation of the model of functional glutenin. A, glutenin II subunits; B, intrapolypeptide disulfide bond; C, interpolypeptide disulfide bond; D, glutenin I subunits; E, secondary bonds, eg. hydrogen bonds and hydrophobic interactions.

## LITERATURE CITED

- BIETZ, J. A., SHEPHERD, K. W., and WALL, J. S. 1975. Single-kernel analysis of glutenin: Use in wheat genetics and breeding. *Cereal Chem.* 52:513.
- BIETZ, J. A., and WALL, J. S. 1973. Isolation and characterization of gliadin-like subunits from glutenin. *Cereal Chem.* 50:537.
- BIETZ, J. A., and WALL, J. S. 1975. The effect of various extractants on subunit composition and associations of wheat glutenin. *Cereal Chem.* 52:145.
- DALEK-ZAWISTOSKA, U., BARTOSZEWICZ, K., and KACZKOWSKI, J. 1975. The equilibrium between the high- and low-molecular fractions of wheat gluten. *Bull. Acad. Pol. Sci.* 23:75.
- DANNO, G. KANAZAWA, K., and NATAKE, M. 1975. Cleavage of disulfide bonds of wheat glutenin by mercuric chloride. *Agric. Biol. Chem.* 39:1379.
- EWART, J. A. D. 1968. A hypothesis for the structure and rheology of glutenin. *J. Sci. Food Agric.* 19:618.
- EWART, J. A. D. 1972. A modified hypothesis for the structure and rheology of glutelins. *J. Sci. Food Agric.* 23:687.
- EWART, J. A. D. 1977. Re-examination of the linear glutenin hypothesis. *J. Sci. Food Agric.* 28:191.
- JONES, R. W., TAYLOR, N. W., and SENTI, F. R. 1959. Electrophoresis and fractionation of wheat gluten. *Arch. Biochem. Biophys.* 84:363.
- KASARDA, D. D., BERNARDIN, J. E., and NIMMO, C. C. 1976. Wheat proteins, p. 158. In: POMERANZ, Y. (ed.). *Advances in Cereal Science and Technology*. Amer. Assoc. Cereal Chem.: St. Paul, MN.
- KHAN, K., and BUSHUK, W. 1977. Studies of glutenin. IX. Subunit composition by sodium dodecyl sulfate-polyacrylamide gel electrophoresis at pH 7.3 and 8.9. *Cereal Chem.* 54:588.
- KOBREHEL, K., and BUSHUK, W. 1977. Studies of glutenin. X. Effect of fatty acids and their sodium salts on solubility in water. *Cereal Chem.* 54:833.
- MECHAM, D. K., COLE, E. W., and NG, H. 1972. Solubilizing effect of mercuric chloride on the "gel" protein of wheat flour. *Cereal Chem.* 49:62.
- MITA, T., and YONEZAWA, D. 1971. Separation of component-polypeptides of glutenin by isoelectric focusing. *Agric. Biol. Chem.* 35:1792.
- ORTH, R. A., and BUSHUK, W. 1972. A comparative study of the proteins of wheats of diverse baking qualities. *Cereal Chem.* 49:268.
- ORTH, R. A., and BUSHUK, W. 1973a. Studies of glutenin. I. Comparison of preparative methods. *Cereal Chem.* 50:106.
- ORTH, R. A., and BUSHUK, W. 1973b. Studies of glutenin. II. Relation of variety, location of growth, and baking quality to molecular weight distribution of subunits. *Cereal Chem.* 50:191.
- SHOGREN, M. D., FINNEY, K. F., and HOSENEY, R. C. 1969. Functional (breadmaking) and biochemical properties of wheat flour components. I. Solubilizing gluten and flour proteins. *Cereal Chem.* 46:93.
- TANAKA, K., and BUSHUK, W. 1973. Changes in flour proteins during dough mixing. I. Solubility results. *Cereal Chem.* 50:590.

[Received March 16, 1978. Accepted June 14, 1978]